

Outdoor Unit Lineup



25.2-40kW



45-61.5kW

V8 Indoor Unit

Type	One-way Cassette	Two-way Cassette	Compact Four-way Cassette
Indoor Unit	 1.8-7.1kW, 7 models	 2.2-7.1kW, 6 models	 1.5-6.3kW, 7 models
Type	Four-way Cassette	Arc Duct	Medium Static Pressure Duct
Indoor unit	 2.8-18kW, 12 models	 1.5-11.2kW, 10 models	 1.5-16kW, 13 models
Type	High Static Pressure Duct	Wall Mounted	Ceiling & Floor
Indoor unit	 5.6-56kW, 16 models	 1.5-8kW, 8 models	 3.6-14kW, 10 models
Type	Floor Standing	Fresh Air Processing Unit	Small Airflow Rate Fresh Air Processing Unit
Indoor unit	 2.2-8kW, 7 models	 22.4-56kW, 7 models	 9-28kW, 5 models

Note: Pictures are for reference only, please refer to the actual product.

2nd Generation DC/AC Indoor Unit

Type	One-way Cassette	Two-way Cassette	Compact Four-way Cassette	Four-way Cassette	Medium Static Pressure Duct
Indoor Unit	 1.8-7.1kW, 7 models	 2.2-7.1kW, 6 models	 2.2-4.5kW, 5 models (DC) 1.8-4.5kW, 5 models (AC)	 2.8-16kW, 11 models (DC) 2.8-14kW, 10 models (AC)	 2.2-16kW, 11 models (DC) 2.2-14kW, 10 models (AC)
Type	High Static Pressure Duct	Wall Mounted	Ceiling & Floor	Floor Standing	Fresh Air Processing Unit
Indoor Unit	 7.1-56kW, 12models	 2.2-9kW, 8 models	 3.6-16kW, 9 models (DC) 3.6-14kW, 8 models (AC)	 2.2-8kW, 7 models (DC)	 12.5-56kW, 7 models (DC)

Specification

HP			8	10	12	14
Model			MVI-252WV2RN1(B)	MVI-280WV2RN1(B)	MVI-335WV2RN1(B)	MVI-400WV2RN1(A)
Power supply	V/N/Hz		380-415/3/50			
Cooling (T1) ¹	Capacity	kW	25.2	28	33.5	40
		kBtu/h	86.0	95.5	114.3	136.5
	Power input	kW	7.6	9.1	11.6	15.7
Heating (Rated) ²	EER		3.30	3.09	2.90	2.54
	Capacity	kW	25.2	28	33.5	40
		kBtu/h	86.0	95.5	114.3	136.5
Heating (Max) ²	Power input	kW	6.1	7.0	9.1	11.7
	COP		4.10	4.02	3.68	3.42
	Capacity	kW	27	31.5	37.5	45
SEER			4.10	4.02	3.68	3.42
			3.47	3.30	3.25	3.09
			7.25	7.05	6.91	6.65
η _{s,c}	%	287.0	279.0	273.4	263.0	
SCOP		4.15	4.11	4.11	4.15	
η _{s,h}	%	163.0	161.4	161.4	163.0	
Connected indoor unit	Total capacity		50-130%	50-130%	50-130%	50-130%
	Maximum quantity		13	16	19	23
Compressor	Type		DC inverter	DC inverter	DC inverter	DC inverter
	Quantity		1	1	1	1
Fan	Type		Propeller	Propeller	Propeller	Propeller
	Motor type		DC	DC	DC	DC
Refrigerant	Static pressure	Pa	0-35 (standard)35-80 (customized)			
	Type		R410A	R410A	R410A	R410A
Pipe connections ³	Factory charge	kg	6.1	6.1	6.4	7.4
	Liquid pipe	mm	Φ12.7	Φ12.7	Φ12.7	Φ12.7
Sound pressure level ⁴	Gas pipe	mm	Φ25.4	Φ25.4	Φ25.4	Φ25.4
		dB(A)	56	57	58	59
Sound power level ⁴		dB(A)	76	79	81	82
		dB(A)	76	79	81	82
Net dimensions (WxHxD)		mm	1130x1760x580	1130x1760x580	1130x1760x580	1130x1760x580
	Packed dimensions (WxHxD)	mm	1210x1916x597	1210x1916x597	1210x1916x597	1210x1916x597
Net weight		kg	182	182	185	187
	Gross weight	kg	196	196	199	201
Ambient temp. operation range	Cooling	°C	-15 to 55	-15 to 55	-15 to 55	-15 to 55
	Heating	°C	-30 to 30	-30 to 30	-30 to 30	-30 to 30

HP			16	18	20	22
Model			MVI-450WV2RN1(A)	MVI-500WV2RN1(A)	MVI-560WV2RN1(A)	MVI-615WV2RN1(A)
Power supply	V/N/Hz		380-415/3/50			
Cooling (T1) ¹	Capacity	kW	45	50	56	61.5
		kBtu/h	153.5	170.6	191.1	209.8
	Power input	kW	16.0	19.5	22.9	30.8
Heating (Rated) ²	EER		2.82	2.57	2.45	2.00
	Capacity	kW	45	50	56	61.5
		kBtu/h	153.5	170.6	191.1	209.8
Heating (Max) ²	Power input	kW	12.2	13.7	15.5	17.8
	COP		3.68	3.65	3.62	3.46
	Capacity	kW	50	56.5	63	69
SEER			170.6	192.8	215.0	235.4
			15.7	18.1	20.3	22.5
			3.19	3.12	3.10	3.07
η _{s,c}	%	6.77	6.47	6.30	6.15	
SCOP		267.8	255.8	249.0	243.0	
η _{s,h}	%	4.23	4.17	4.07	4.00	
Connected indoor unit	Total capacity		50-130%	50-130%	50-130%	50-130%
	Maximum quantity		26	29	33	36
Compressor	Type		DC inverter	DC inverter	DC inverter	DC inverter
	Quantity		1	1	1	1
Fan	Type		Propeller	Propeller	Propeller	Propeller
	Motor type		DC	DC	DC	DC
Refrigerant	Static pressure	Pa	0-35 (standard)35-80 (customized)			
	Type		R410A	R410A	R410A	R410A
Pipe connections ³	Factory charge	kg	8	8	8.5	8.5
	Liquid pipe	mm	Φ15.9	Φ15.9	Φ15.9	Φ15.9
Sound pressure level ⁴	Gas pipe	mm	Φ28.6	Φ28.6	Φ28.6	Φ28.6
		dB(A)	60	61	61	62
Sound power level ⁴		dB(A)	86	88	89	89
		dB(A)	86	88	89	89
Net dimensions (WxHxD)		mm	1250x1760x580	1250x1760x580	1250x1760x580	1250x1760x580
	Packed dimensions (WxHxD)	mm	1330x1916x597	1330x1916x597	1330x1916x597	1330x1916x597
Net weight		kg	214	214	234	234
	Gross weight	kg	229	229	249	249
Ambient temp. operation range	Cooling	°C	-15 to 55	-15 to 55	-15 to 55	-15 to 55
	Heating	°C	-30 to 30	-30 to 30	-30 to 30	-30 to 30

Notes:

- Indoor temperature 27°C DB, 19°C WB; outdoor temperature 35°C DB; equivalent refrigerant piping length 7.5m with zero level difference; connect to Cassette type indoor unit.
- Indoor temperature 20°C DB; outdoor temperature 7°C DB, 6°C WB; equivalent refrigerant piping length 7.5m with zero level difference; connect to Cassette type indoor unit.
- Diameters given are those of the unit's stop valves.
- Sound pressure level is measured at a position 1m in front of the unit and 1.3m above the floor in a semi-anechoic chamber.

B-V8EasyFitEU202308



V8 EasyFit Series
25.2-61.5kW



Support Any Topology Communication

In addition to the traditional daisy chain connection, the communication wire supports tree connection, star connection, ring connection and so on. The wiring is flexible, which greatly reduces the installation cost and has no possibility of wrong connection on site.

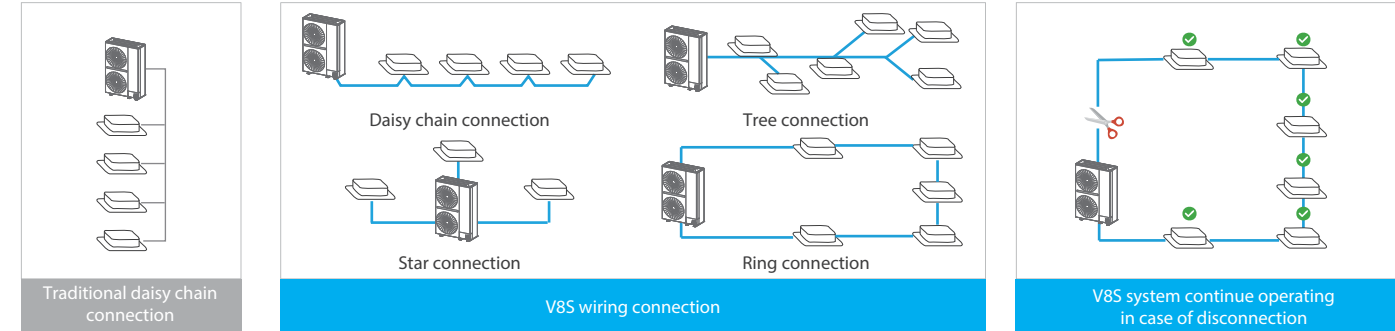

Super Anti-interference Capability

Special waveform restoration technology enhances anti-interference performance for more stable communication.

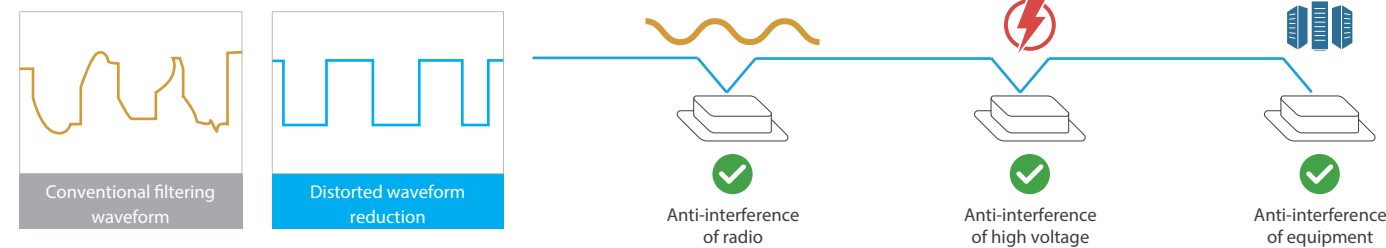

Flexible Power Supply for Indoor Units

HyperLink's unique communication method allows the indoor units to be powered not only by a uniform power supply, but also by individual and zone power supplies, making it particularly suitable for each shop in a large complex building, which can independently power on and off its own indoor units.

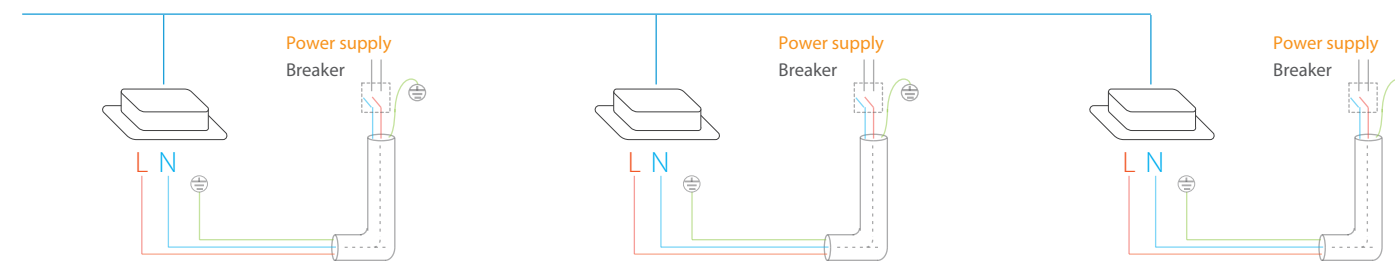

Full DC Inverter Technology

The EasyFit Series VRF uses full DC inverter compressor and fan motor to achieve high precision stepless speed adjustment according to system operation, and ensures that the system is always in optimum condition, operating more efficiently, more consistently and with less noise.

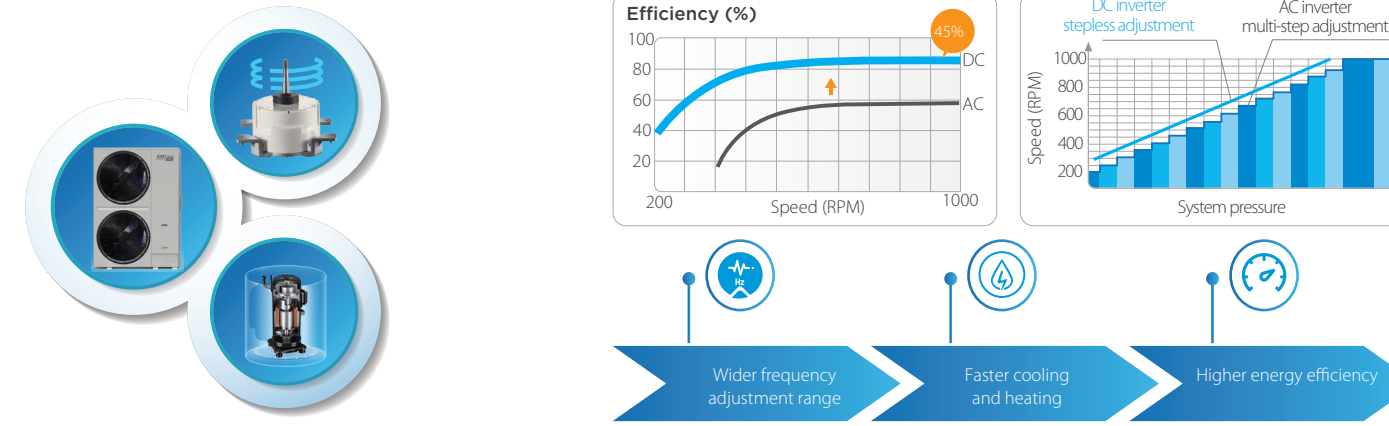

Space Saving

The compact, slim designed outdoor unit can easily be installed on a balcony, realizing complete system installation within each floor. Which release more useful utilization of the space on the building rooftop.



Easy Transportation

EasyFit Series VRF can be transported by elevator which makes installation dramatically easy, and effectively reduces time and labor thanks to the small size.



Flexible Indoor Units Connection

A single outdoor unit supports up to 36 indoor units, freeing up considerable space outside. Use your backyard more wisely with much more space available created by less number of outdoor units.

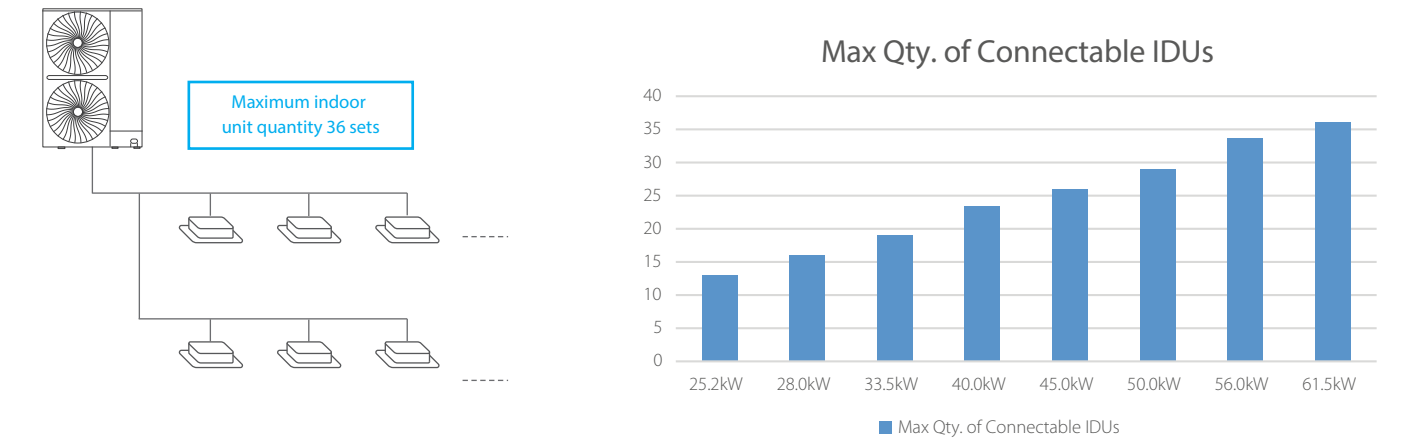

Wide Combination Ratio

Compared to traditional VRF with combination ratio of 50-130%, the EasyFit Series VRF can be extended to 50-200%, and the wider combination ratio allows for more flexible system configuration. The larger combination ratio can be applied to long-term part-load operation scenarios, allowing for further reduction in installation costs.

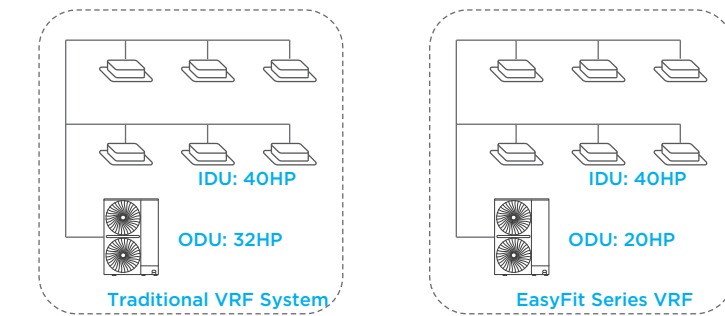

Flexible Piping Design

The total piping length of the EasyFit system can be up to 560m, the level difference between indoor and outdoor units can be up to 50m and the level difference between indoor units can be up to 30m, making the EasyFit Series VRF perfectly suitable for all buildings.

Pipe Length	Permitted value(m)		25.2-61.5kW
	Total Pipe Length(Actual)		
Longest piping ¹	Actual Length		560
	Equivalent Length		175
	Equivalent piping length (from the farthest IDU to the first indoor branch joint/header) ²		40/90*
Level difference	Level difference between IDU~ODU ³	Outdoor Unit Up	50
		Outdoor Unit Down	40
	Level difference between IDU~IDU ⁴		30

*The longest length after first branch is 40m as standard but can be extended to up to 90m under certain conditions. Please contact your local dealer for further information.

